

REMS Mini-Press 22 V ACC

Teilverzeichnis

Aktueller Stand
siehe www.rems.de
weitere Teile auf Anfrage

Spare parts list

Latest version
see www.rems.de
other parts on request

Liste des pièces

Situation actuelle
voir www.rems.de
autres pièces sur demande

Elenco dei pezzi

Ultimo aggiornamento
vedi www.rems.de
altri ricambi su richiesta

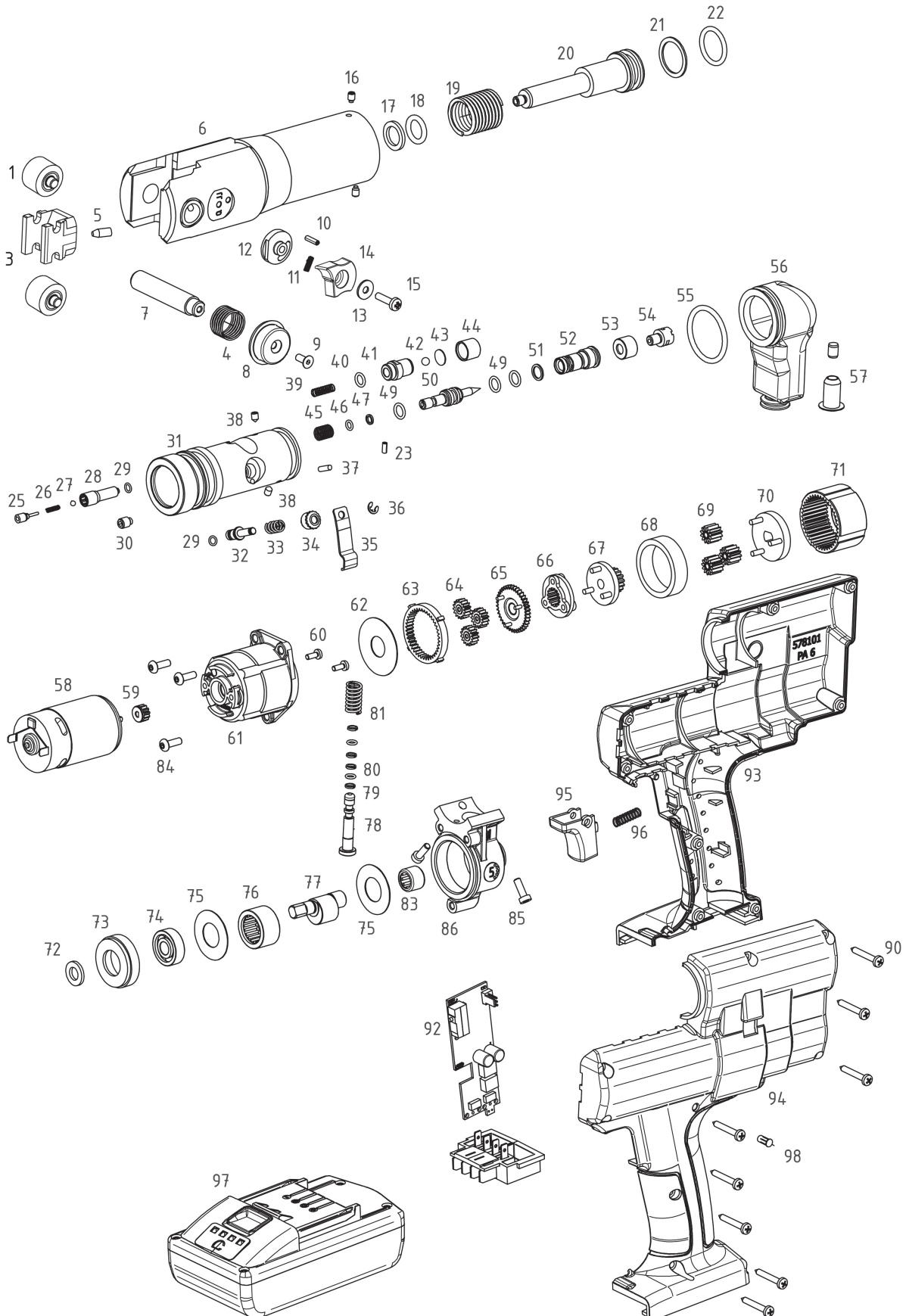

REMS Mini-Press 22V ACC

deu	eng	fra	ita	
1 Pressrolle	Press roller	Galet presseur	Rulli di pressione	578213R
3 Rollenträger	Roller holder	Support galets	Portarulli	578225R
4 Druckfeder	Pressure spring	Ressort de compression	Molla di compressione	061083
5 Stift	Pin	Tige	Spina	578228R
6 Antriebsgehäuse	Housing	Carter	Carcassa	578201R
7 Zangenhaltebolzen	Tongs shank	Axe de serrage de la pince	Bullone della ganascia	578236R
8 Knopf	Button	Bouton	Pulsante	578254R
— Presszangenverriegelung Pos. 8, 10–15	Tongs lock Pos. 8, 10–15	Verrouillage Pos. 8, 10–15	Perno fissaggio pinza Pos. 8, 10–15	578238R
9 Senkschraube	Countersunk screw	Vis à tête fraisée	Vite a testa svasata	083165
10 Spiralspannstift	Spiral pin	Goupille spiralee	Spina elastica	088123
11 Druckfeder	Pressure spring	Ressort de compression	Molla di compressione	061072
13 Scheibe	Washer	Rondelle	Ranella	086055
15 Linsenschraube	Fillister head screw	Vis tête fraisée bombée	Vite a testa svasata con perno	083169
16 Gewindestift	Grub screw	Vis sans tête	Perno filettato	084079
17 O-Ring	Locking ring	Joint torique	Guarnizione O-Ring	060252
18 Scheibe	Washer	Rondelle	Ranella	578205R
19 Druckfeder	Pressure spring	Ressort de compression	Molla di compressione	061058
21 Stützring	Back-up ring	Bague d'appui	Rondella d'appoggio	060267
22 O-Ring	Locking ring	Joint torique	Guarnizione O-Ring	060255
— Vorschubkolben kompl. Pos. 19 – 22	Feed piston compl. Pos. 19 – 22	Piston d'avancement compl. Pos. 19 – 22	Pistone di avanzamento compl. Pos. 19 – 22	578202R
— Hydraulikblock kompl. im Tausch Pos. 21–22, 25–50, 52–57	Hydraulic block compl. Pos. 21–22, 25–50, 52–57	Bloc hydraulique compl. Pos. 21–22, 25–50, 52–57	Blocco idraulico compl. Pos. 21–22, 25–50, 52–57	578246
35 Hebel	Lever	Levier	Leva	578208R
55 O-Ring	Locking ring	Joint torique	Guarnizione O-Ring	060383
— Ausgleichsbehälter ET-Set Pos. 55 und 56	Compensating reservoir spares kit Pos. 55 and 56	Reservoir de compensation set-PD Pos. 55 et 56	Contentitore di compensazione set ricambi Pos. 55 e 56	578131R
57 Stopfen mit Stabmagnet	Plug with magnet	Bouchon avec magnet	Tappo con calamita	571249R
— Gleichstrommotor mit Planetengetriebe Pos. 58 – 71 und 84	D.C. Motor with planetary gear drive Pos. 58 – 71 and 84	Moteur à courant continu avec engranage planetaire Pos. 58 – 71 et 84	Motore monofasico con ingranaggio planetario Pos. 58 – 71 e 84	578151R
— Pumpe kompl. Pos. 72–77, 83, 85 und 86	Pump compl. Pos. 72–77, 83, 85 and 86	Pompe compl. Pos. 72–77, 83, 85 et 86	Pompa compl. Pos. 72–77, 83, 85 e 86	578224R
— Pumpenkolben kompl. Pos. 78 – 81	Pump piston compl. Pos. 78 – 81	Piston de pompe compl. Pos. 78 – 81	Pistone a pompa compl. Pos. 78 – 81	578271R
90 Blechschraube	Sheet metal screw	Vis à tôle	Vite da lamiera	083064
92 Schalter	Switch	Interrupteur	Interruttore	578109R22
— Gehäuseschalen Pos. 93 und 94	Housing shells Pos. 93 and 94	Coquille carcasse Pos. 93 et 94	Calotta carcassa Pos. 93 e 94	578140R
95 Taste	Button	Bouton	Pulsante	578110ROH
96 Druckfeder	Pressure spring	Ressort de compression	Molla di compressione	061065
97 REMS Akku 21,6 V, 1,5 Ah Li-Ion	REMS Akku 21,6 V, 1,5 Ah Li-Ion	REMS Akku 21,6 V, 1,5 Ah Li-Ion	REMS Akku 21,6 V, 1,5 Ah Li-Ion	571570R22
98 Lichtleiter	Light conductor	Conducteur de lumière	Conduttore di luce	039085 085